

2400 BOUNDARY ROAD
BURNABY B.C. V5M3Z3
CANADA

T: 604.482.2000
F: 604.482.2007

SOUND STAGE: 9

FEATURES

- 13,000 sq.ft.
- Soundproofing
- 16'x16' Door

TRUSS

- 1 & 2 at 19' 5"
- 3, 4, & 5 at 18'

Distances measured from floor to underside of truss

SITE LEGEND

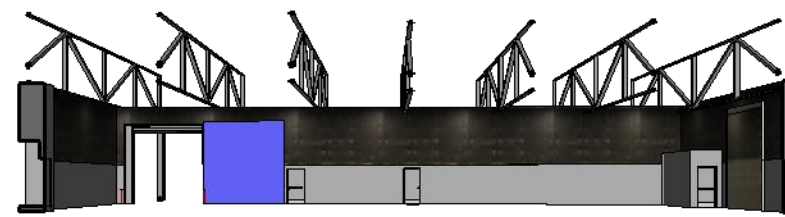
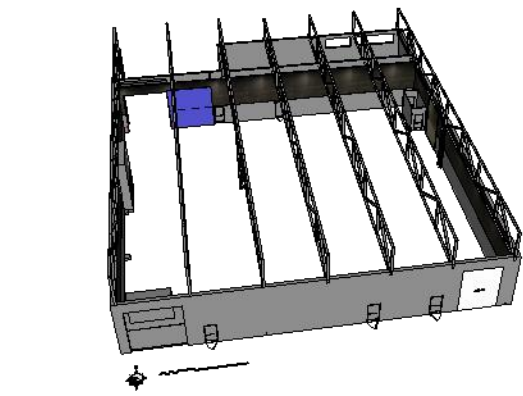
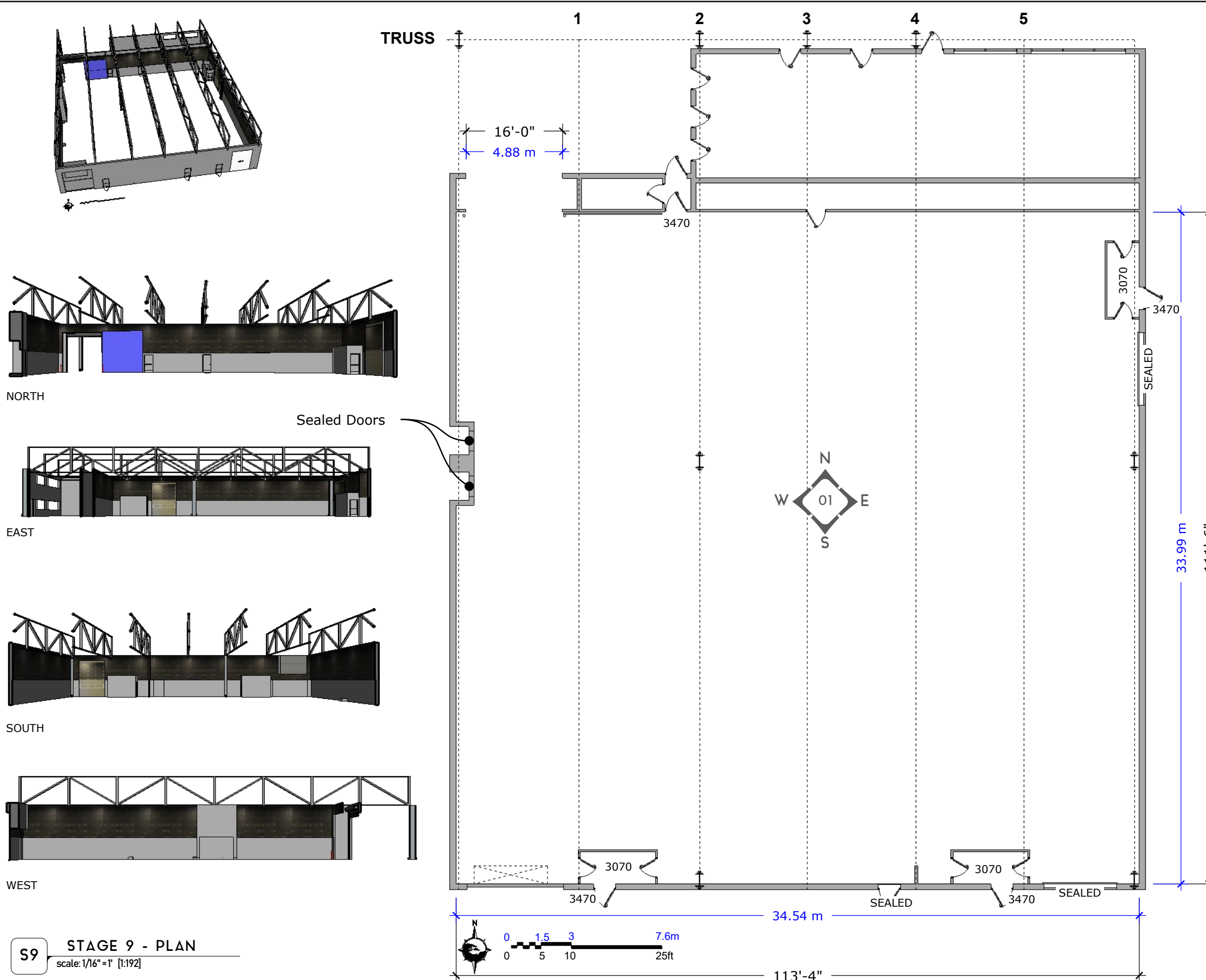
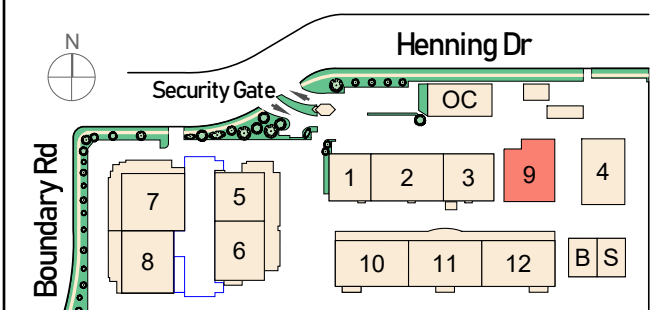

NORTH

Sealed Doors

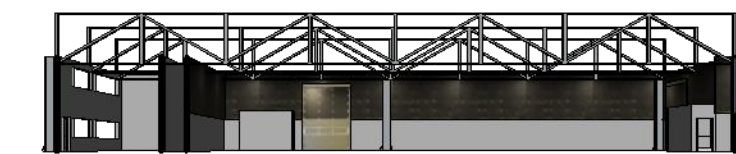

EAST

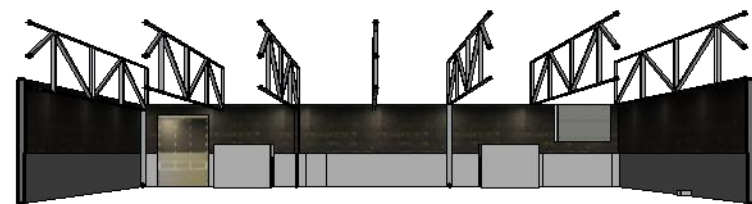

SOUTH

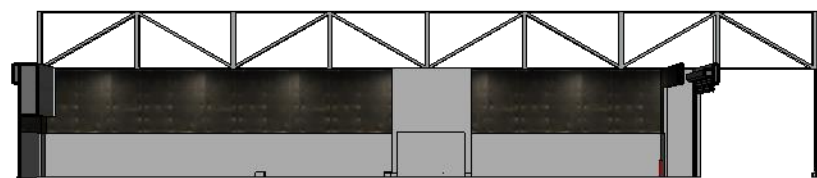

WEST

S9 STAGE 9 - PLAN
scale: 1/16" = 1' [1:192]



ELEV NORTH
scale: 1/16" = 1' [1:192]

N

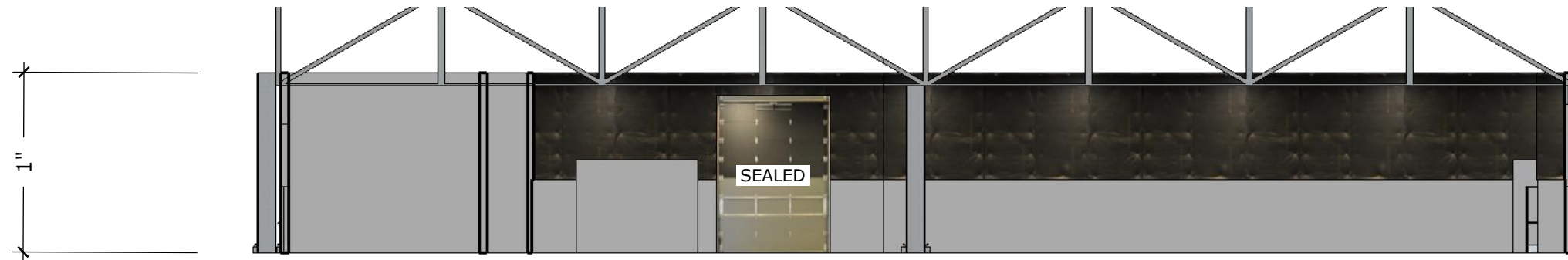

ELEV EAST
scale: 1/16" = 1' [1:192]

E



ELEV SOUTH
scale: 1/16" = 1' [1:192]

S

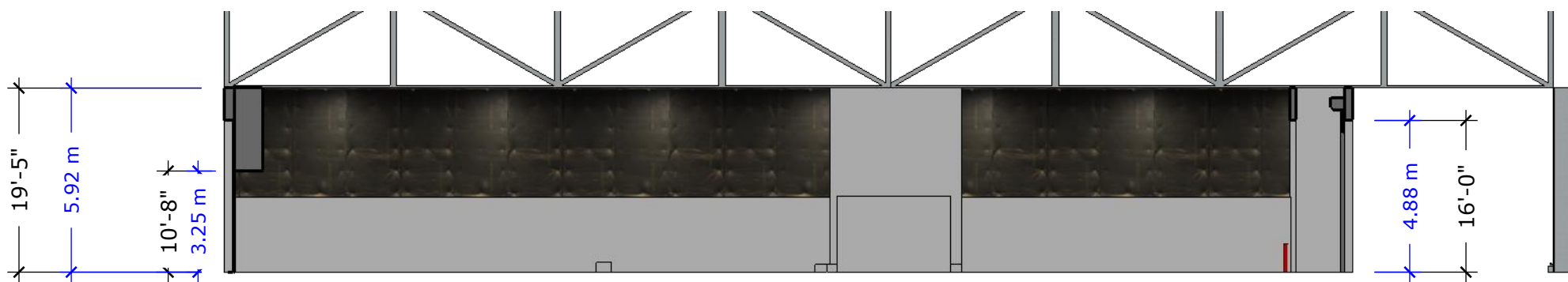

ELEV WEST
scale: 1/16" = 1' [1:192]

W



2400 BOUNDARY ROAD
BURNABY B.C. V5M3Z3
CANADA

T: 604.482.2000
F: 604.482.2007

SOUND STAGE:

FEATURES

- 13,000 sq.ft.
- Soundproofing
- 16'x16' Door

TRUSS

- 1 & 2 at 19' 5"
- 3,4, & 5 at 18'

Distances measured from floor to underside of truss

SITE LEGEND

